

## 1200V 450A IGBT Half Bridge Module

## 1200V 450A IGBT 半桥模块

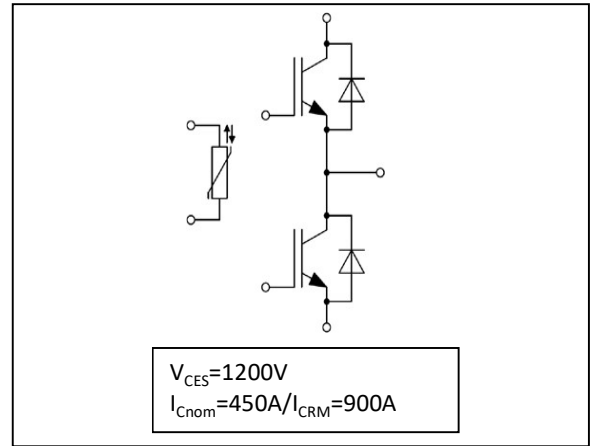

### Features:

- 1200V Trench+ Field Stop technology
- Freewheeling diodes with fast and soft reverse recovery
- $V_{CE(sat)}$  with positive temperature coefficient
- Low switching losses
- Short circuit ruggedness

### Typical Applications:

- Motor/Servo Drives
- Wind Turbines Converters
- PV Inverters
- Energy Storage Converters
- UPS

### 产品特性:

- 1200V 沟槽栅+场截止技术
- 快速的软恢复特性续流二极管
- 导通压降具有正温度系数
- 低开关损耗
- 良好的短路稳定性

### 典型应用:

- 电机/伺服驱动器
- 风电变流器
- 光伏逆变器
- 储能变流器
- 不间断电源

Package / 封装

Item	Symbol	Conditions	Values	Unit
绝缘测试电压 Isolation test voltage	$V_{ISOL}$	RMS, f = 50 Hz, t =1 min	3.0	kV
模块基板材料 Material of module baseplate			Cu	
内部绝缘 Internal isolation		基本绝缘 (class 1, IEC 61140) Basic insulation (class 1, IEC 61140)	$Al_2O_3$	
爬电距离 Creepage distance	$d_{Creep}$	端子-散热片/terminal to heatsink	14.5	mm
	$d_{Creep}$	端子-端子/terminal to terminal	13.0	
电气间隙 Clearance	$d_{Clear}$	端子-散热片/terminal to heatsink	12.5	mm
	$d_{Clear}$	端子-端子/terminal to terminal	10.0	
相对电痕指数 Comparative tracking index	CTI		> 200	

Item	Symbol	Conditions	Values			Unit
			Min.	Typ.	Max.	
杂散电感, 模块 Stray inductance module	$L_{SCE}$			20		nH
模块引线电阻, 端子-芯片 Module lead resistance, terminals - chip	$R_{CC'+EE'}$	$T_C=25^{\circ}C$		1.10		m $\Omega$
储存温度 Storage temperature	$T_{stg}$		-40		125	$^{\circ}C$
模块安装的安装扭矩 Mounting torque for module mounting	M5		3		6	Nm
端子联接扭矩 Terminal connection torque	M6		3		6	Nm
重量 Weight	G			345		g

IGBT

Maximum Rated Values / 最大额定值

Item	Symbol	Conditions	Values	Unit
集电极-发射极电压 Collector-emitter Voltage	$V_{CES}$	$T_{vj}=25^{\circ}C$	1200	V
栅极-发射极电压 Maximum gate-emitter voltage	$V_{GES}$		$\pm 20$	V
瞬态栅极-发射极电压 Transient gate-emitter voltage	$V_{GES}$	$t_p \leq 10\mu s, D=0.01$	$\pm 30$	V
连续集电极直流电流 Continuous DC collector current	$I_C$	$T_C=25^{\circ}C$	675	A
		$T_C=100^{\circ}C$	450	
最大脉冲集电极电流 Pulsed collector current, $t_p$ limited by $T_{jmax}$	$I_{Cpulse}$		900	A
功率损耗 Power dissipation	$P_{tot}$		1875	W

Characteristic Values / 特征值

Item	Symbol	Conditions	Values			Unit	
			Min.	Typ.	Max.		
集电极-发射极饱和电压 Collector-emitter saturation voltage	$V_{CE(sat)}$	$I_C=450A, V_{GE}=15V$	$T_{vj}=25^{\circ}C$		1.50	1.80	V
			$T_{vj}=125^{\circ}C$		1.65		
			$T_{vj}=150^{\circ}C$		1.70		
栅极阈值电压 Gate threshold voltage	$V_{GE(th)}$	$V_{CE}=V_{GE}, I_C=18mA$		5.0	5.8	6.5	V
集电极-发射极截止电流 Collector-emitter cut-off current	$I_{CES}$	$V_{CE}=1200V, V_{GE}=0V$	$T_{vj}=25^{\circ}C$			100	$\mu A$
			$T_{vj}=150^{\circ}C$			5	mA
栅极-发射极漏电流 Gate-emitter leakage current	$I_{GES}$	$V_{CE}=0V, V_{GE}=\pm 20V, T_{vj}=25^{\circ}C$		-200		200	nA
栅极电荷 Gate Charge	$Q_G$	$V_{CE}=600V, I_C=450A, V_{GE}=\pm 15V$			5.0		$\mu C$
输入电容 Input Capacitance	$C_{ies}$	$V_{CE}=25V, V_{GE}=0V, f=100kHz$			90.0		nF
输出电容 Output Capacitance	$C_{oes}$				2.84		
反向传输电容 Reverse Transfer Capacitance	$C_{res}$				0.81		
开通延迟时间 (电感负载) Turn-on delay time, inductive load	$t_{d(on)}$	$V_{CC}=600V, I_C=450A$ $R_G=1.8\Omega,$ $V_{GE}=15V$	$T_{vj}=25^{\circ}C$		168		ns
			$T_{vj}=125^{\circ}C$		172		ns
			$T_{vj}=150^{\circ}C$		176		ns
上升时间 (电感负载) Rise Time, inductive load	$t_r$	$V_{CC}=600V, I_C=450A$ $R_G=1.8\Omega,$ $V_{GE}=15V$	$T_{vj}=25^{\circ}C$		80		ns
			$T_{vj}=125^{\circ}C$		88		ns
			$T_{vj}=150^{\circ}C$		92		ns
关断延迟时间 (电感负载) Turn-off delay time, inductive load	$t_{d(off)}$	$V_{CC}=600V, I_C=450A$ $R_G=1.8\Omega,$ $V_{GE}=15V$	$T_{vj}=25^{\circ}C$		624		ns
			$T_{vj}=125^{\circ}C$		668		ns
			$T_{vj}=150^{\circ}C$		672		ns
下降时间 (电感负载) Fall time, inductive load	$t_f$	$V_{CC}=600V, I_C=450A$ $R_G=1.8\Omega,$ $V_{GE}=15V$	$T_{vj}=25^{\circ}C$		216		ns
			$T_{vj}=125^{\circ}C$		348		ns
			$T_{vj}=150^{\circ}C$		356		ns
开通损耗能量 (每脉冲) Turn-on energy loss per pulse	$E_{on}$	$V_{CC}=600V, I_C=450A$ $R_G=1.8\Omega,$ $V_{GE}=15V$	$T_{vj}=25^{\circ}C$		17.2		mJ
			$T_{vj}=125^{\circ}C$		27.1		mJ
			$T_{vj}=150^{\circ}C$		30.0		mJ
关断损耗能量 (每脉冲) Turn off Energy loss per pulse	$E_{off}$	$V_{CC}=600V, I_C=450A$ $R_G=1.8\Omega,$ $V_{GE}=15V$	$T_{vj}=25^{\circ}C$		52.3		mJ
			$T_{vj}=125^{\circ}C$		64.3		mJ
			$T_{vj}=150^{\circ}C$		67.1		mJ
短路数据 SC data	$I_{SC}$	$V_{GE} \leq 15V,$ $V_{CC}=800V$	$tp \leq 10\mu s$ $T_{vj}=150^{\circ}C$			2000	A
IGBT结-外壳热阻 IGBT thermal resistance, junction-case	$R_{thJC}$					0.08	K/W
工作温度 Operating Temperature	$T_{Jop}$			-40		150	$^{\circ}C$

**Diode / 二极管**
**Maximum Rated Values / 最大额定值**

Item	Symbol	Conditions	Values			Unit
			Min.	Typ.	Max.	
反向重复峰值电压 Repetitive reverse voltage	$V_{RRM}$	$T_{vj}=25^{\circ}C$		1200		V
连续正向直流电流 Continuous DC forward current	$I_F$			450		A
二极管正向不重复峰值电流 Diode pulsed current, tp limited by $T_{Jmax}$	$I_{Fpulse}$			900		

**Characteristic Values / 特征值**

Item	Symbol	Conditions	Values			Unit	
			Min.	Typ.	Max.		
正向电压 Forward voltage	$V_F$	$I_F=450A, V_{GE}=0V$	$T_{vj}=25^{\circ}C$		2.30	2.70	V
			$T_{vj}=125^{\circ}C$		2.50		
			$T_{vj}=150^{\circ}C$		2.50		
反向恢复时间 Reverse recovery time	$t_{rr}$	$I_F=450A$ $di_F/dt=-5600A/\mu s$ ( $T_{vj}=150^{\circ}C$ )	$T_{vj}=25^{\circ}C$		134		ns
			$T_{vj}=125^{\circ}C$		216		
			$T_{vj}=150^{\circ}C$		227		
反向恢复峰值电流 Peak reverse recovery current	$I_{RRM}$	$V_R=600V,$ $V_{GE}=-15V$	$T_{vj}=25^{\circ}C$		317		A
			$T_{vj}=125^{\circ}C$		376		
			$T_{vj}=150^{\circ}C$		379		
反向恢复电荷 Reverse recovery charge	$Q_{RR}$		$T_{vj}=25^{\circ}C$		40.5		$\mu C$
			$T_{vj}=125^{\circ}C$		63.2		
			$T_{vj}=150^{\circ}C$		65.4		
反向恢复损耗 (每脉冲) Reverse recovery energy loss per pulse	$E_{rec}$		$T_{vj}=25^{\circ}C$		15.9		mJ
			$T_{vj}=125^{\circ}C$		27.0		
			$T_{vj}=150^{\circ}C$		28.1		
二极管结-外壳热阻 Diode thermal resistance, junction-case	$R_{thJC}$				0.13	K/W	
工作温度 Operating Temperature	$T_{Jop}$		-40		150	$^{\circ}C$	

**NTC-Thermistor / 负温度系数热敏电阻**
**Characteristic Values / 特征值**

Item	Symbol	Conditions	Values	Unit
额定电阻值 Rated resistance	$R_{25}$	$T_c=25^{\circ}C$	5.00	k $\Omega$
B-值 B-value	$R_{25/50}$		3375	K

输出特性 (典型)  
Output characteristic (typical)

$I_C = f(V_{CE})$

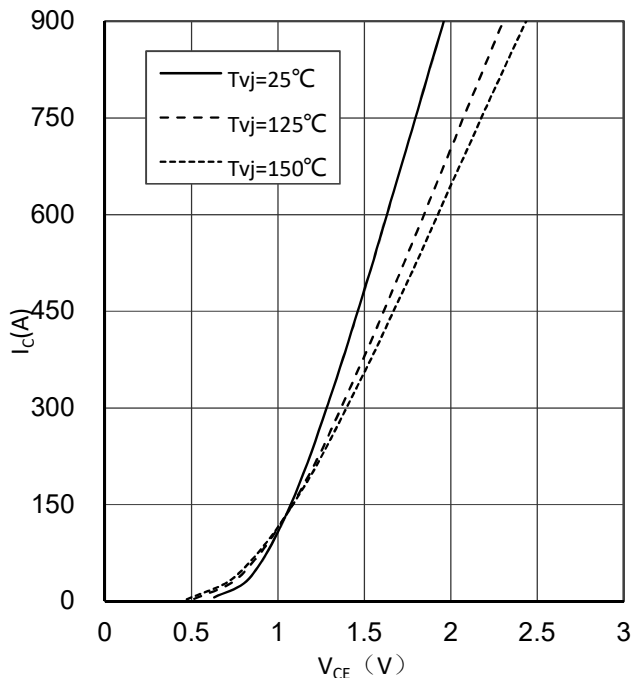

输出特性 (典型)  
Output characteristic (typical)

$I_C = f(V_{CE})$   
 $T_{vj} = 150^\circ\text{C}$

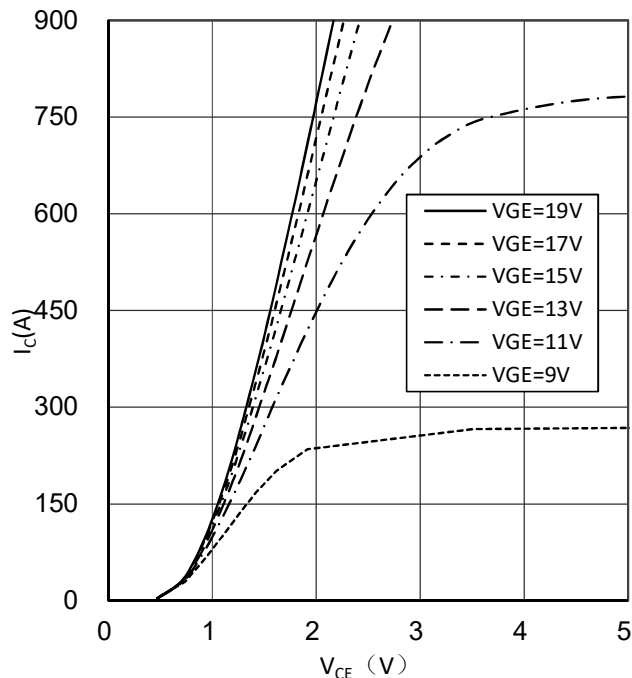

传输特性 (典型)  
Transfer characteristic (typical)

$I_C = f(V_{GE})$   
 $V_{CE} = 20\text{V}$

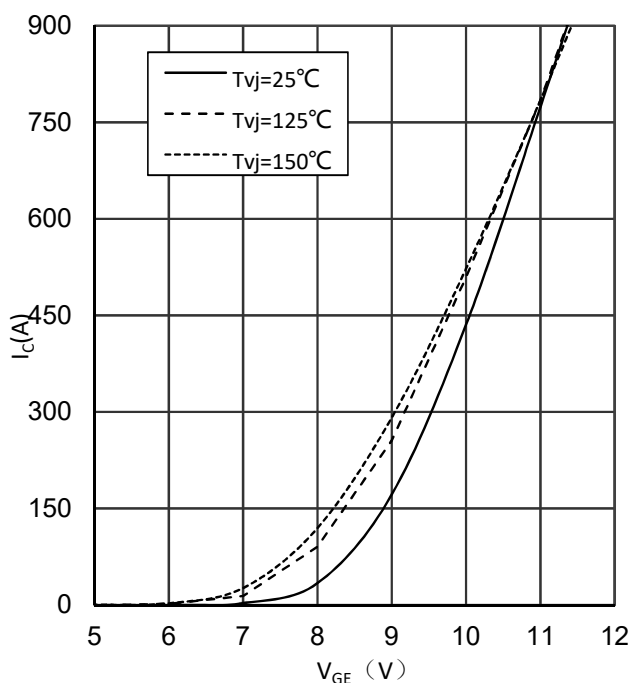

IGBT开关损耗 (典型)  
Switching losses IGBT (typical)

$E = f(R_G)$   
 $V_{GE} = \pm 15\text{V}, I_C = 450\text{A}, V_{CE} = 600\text{V}$

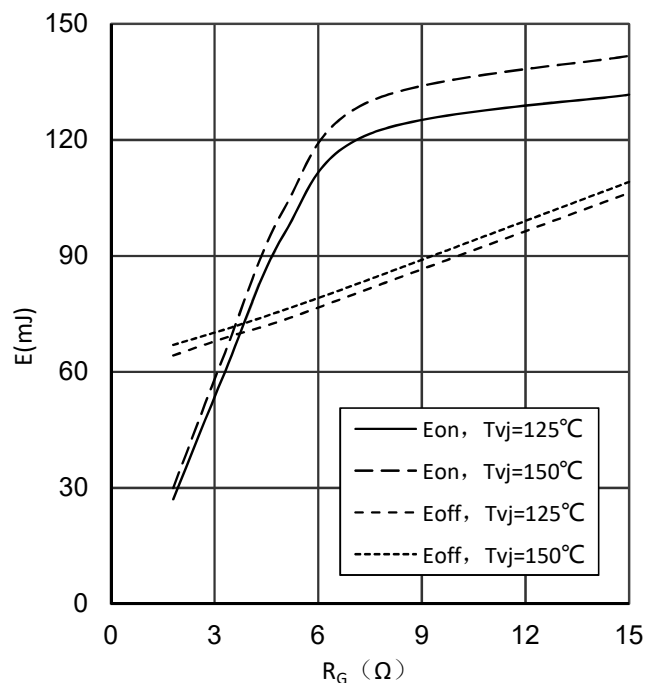

IGBT开关损耗 (典型)

Switching losses IGBT (typical)

$E = f(I_C)$

$V_{GE} = \pm 15V, R_G = 1.8\Omega, V_{CE} = 600V$

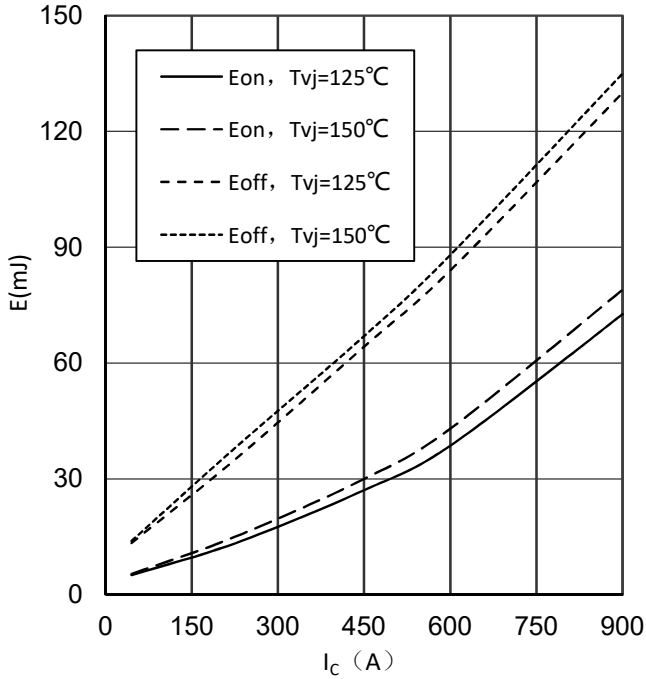

反偏安全工作区 (RBSOA)

Reverse bias safe operating area(RBSOA)

$I_C = f(V_{CE})$

$V_{GE} = \pm 15V, R_{goff} = 3.3\Omega, T_{vj} = 150^\circ C$

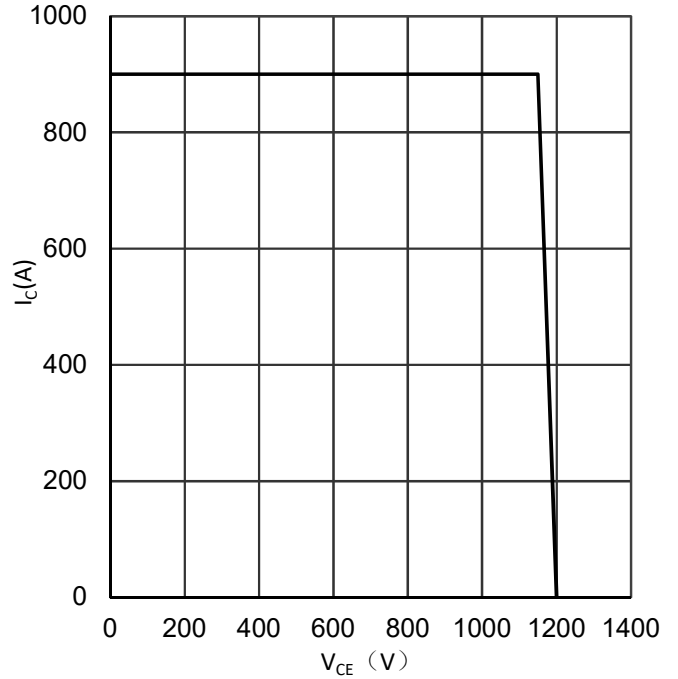

电容 (典型)

Typical capacitance as a function of collector-emitter voltage

$C = f(V_{CE})$

$f = 100\text{ kHz}, V_{GE} = 0V$

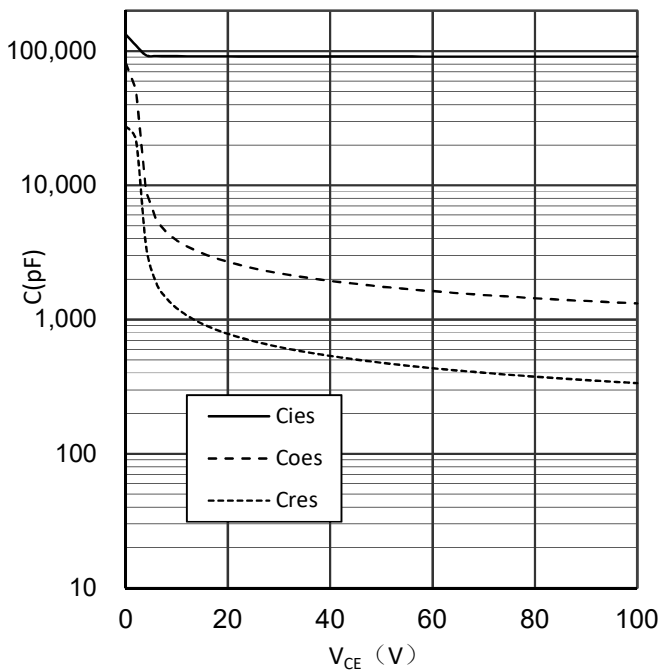

门极电荷 (典型)

Gate charge (typical)

$V_{GE} = f(Q_G)$

$I_C = 450A, V_{CE} = 600V$

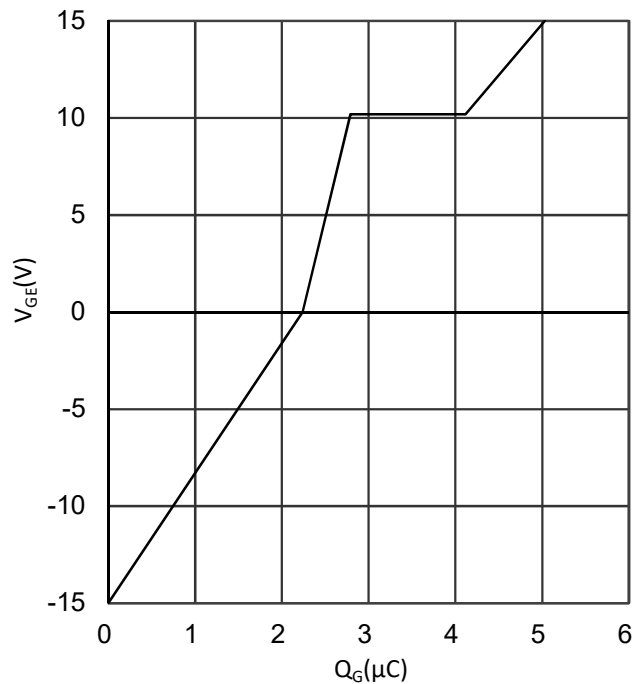

IGBT瞬态热阻抗

IGBT transient thermal impedance as a function of pulse width

$$Z_{th(j-c)} = f(t)$$

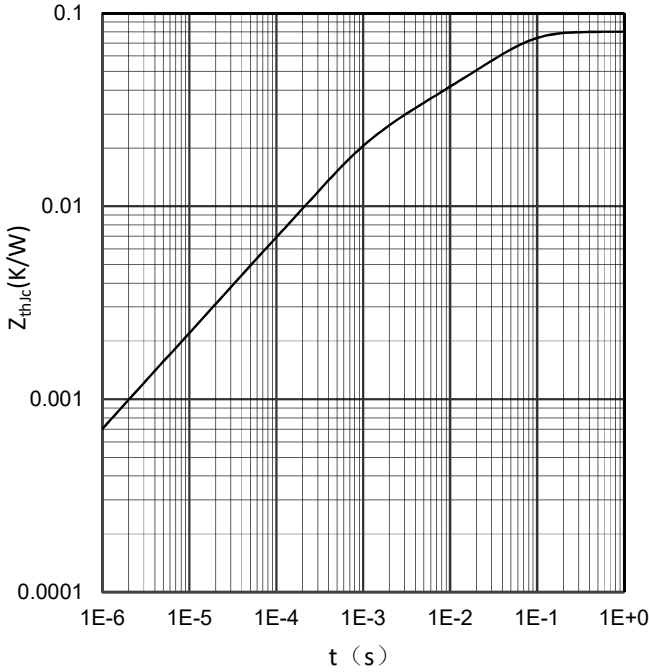

正向偏压特性 二极管 (典型)

Forward characteristic of Diode (typical)

$$I_F = f(V_F)$$

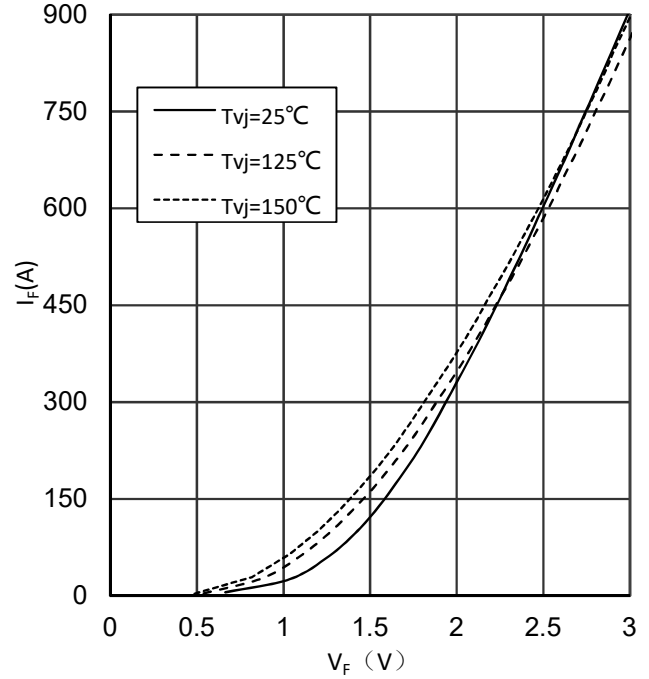

开关损耗 二极管 (典型)

Switching losses Diode (typical)

$$E_{rec} = f(R_G)$$

$I_F = 450A, V_{CE} = 600V$

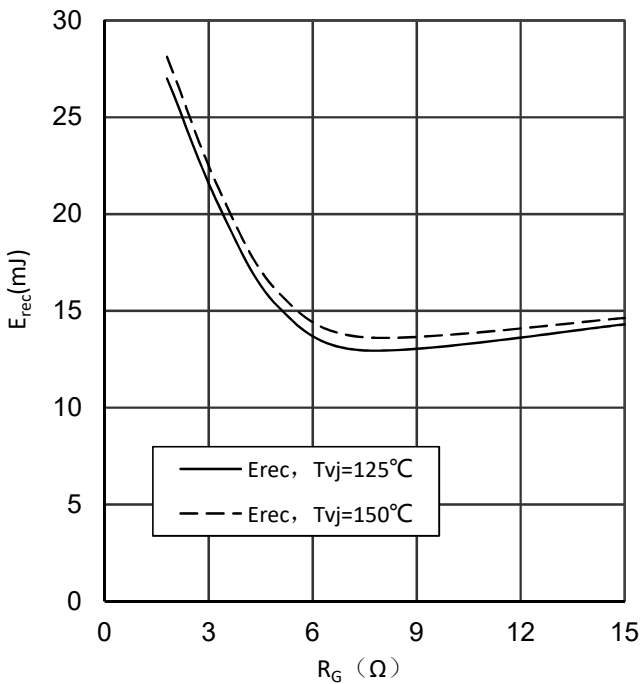

开关损耗 二极管 (典型)

Switching losses Diode (typical)

$$E_{rec} = f(I_F)$$

$R_G = 1.8Ω, V_{CE} = 600V$

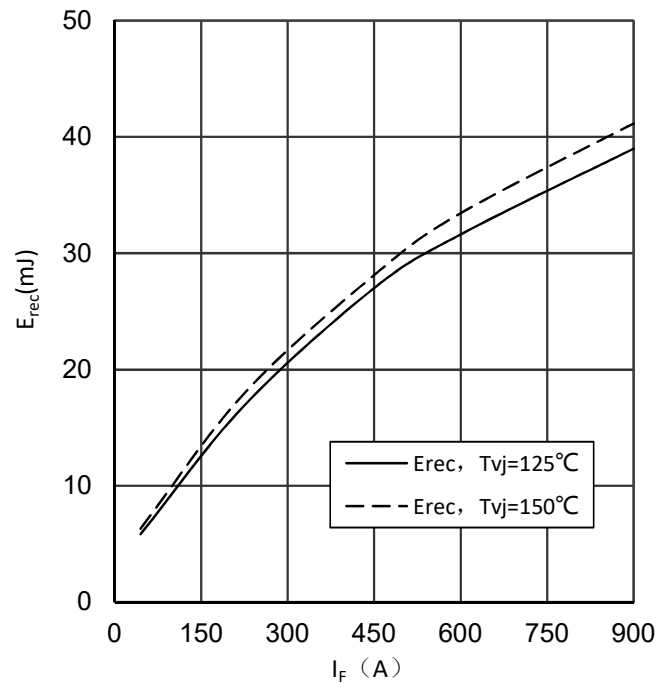



二极管瞬态热阻抗

Diode transient thermal impedance as a function of pulse width

$$Z_{th(j-c)} = f(t)$$

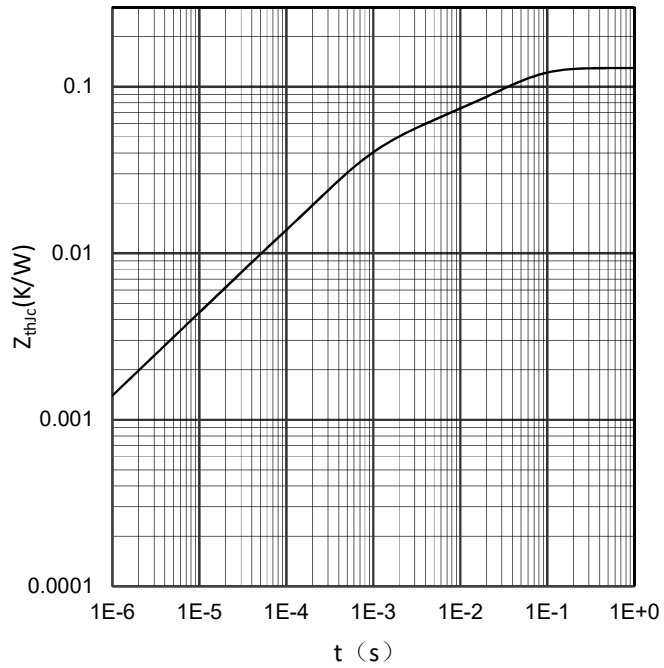

热敏电阻温度特性 (典型)

NTC-Thermistor-temperature characteristic (typical)

$$R = f(T)$$

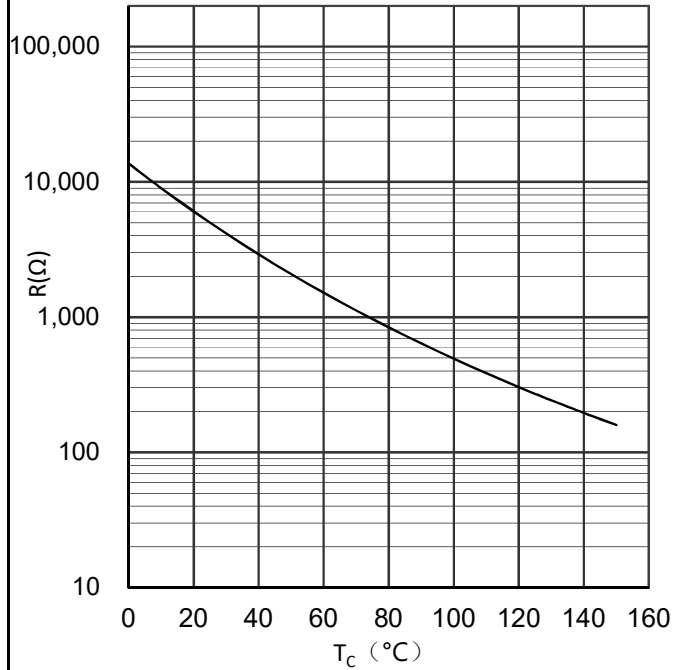

Circuit diagram headline / 接线图

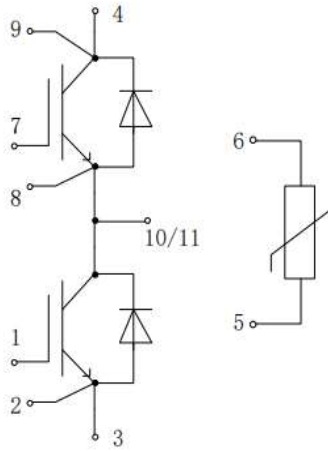

Package outlines / 封装尺寸

